

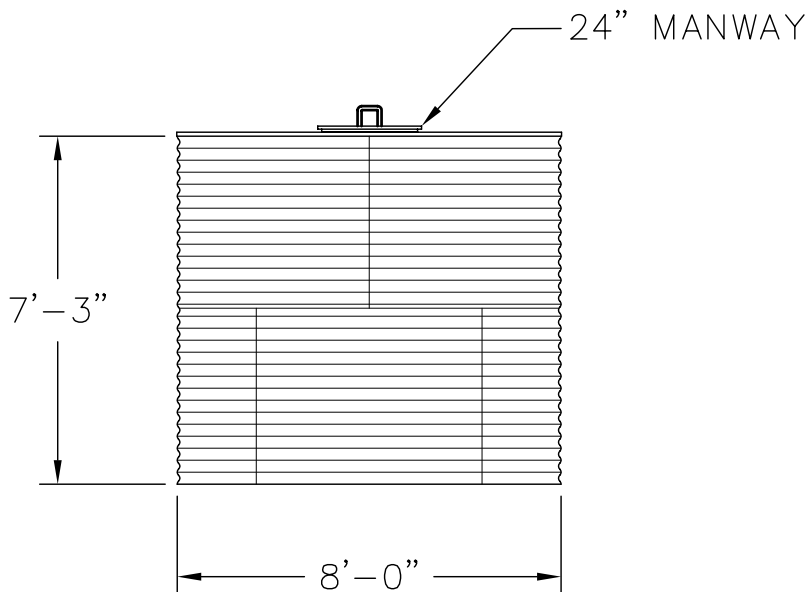

PLAN



ELEVATION

 WATER STORAGE TANKS, INC. 1-800-463-1898 www.corgaltanks.com		BY	DATE	TITLE	
	DWN	RU	8/1/08	MODEL 0802-WT-SAP-CFR	
	CKD	JH	8/1/08	COR GAL STEEL WATER STORAGE TANK	
	ENG	JH	8/1/08	NOMINAL CAPACITY - 2,500 GALLONS (U.S.)	
THE DRAWING DEPICTED ON THIS PRINT AND THE INFORMATION CONTAINED HEREIN ARE PROPRIETARY TO Water Storage Tanks, Inc. AND SHALL NOT BE USED IN WHOLE OR PART WITHOUT THE WRITTEN CONSENT OF Water Storage Tanks, Inc.				DWG. NO.	REV. NO.
				0802-WT-SAP-CFR	A
SIZE	SCALE	SHEET		OF	
A	1/4"=1'-0"	1		1	1